



NEW! U Value **1.4**
Part L compliant with latest building regs
England (1.6) & *Scotland (1.4)
*Effective from Feb 2023



Technical Guide



Steel Door Solutions



modular & portable building association



Raising Standards Safety Assured

DuraPass Therma+ 54mm Leaf Odd Leg Frame – Open Out

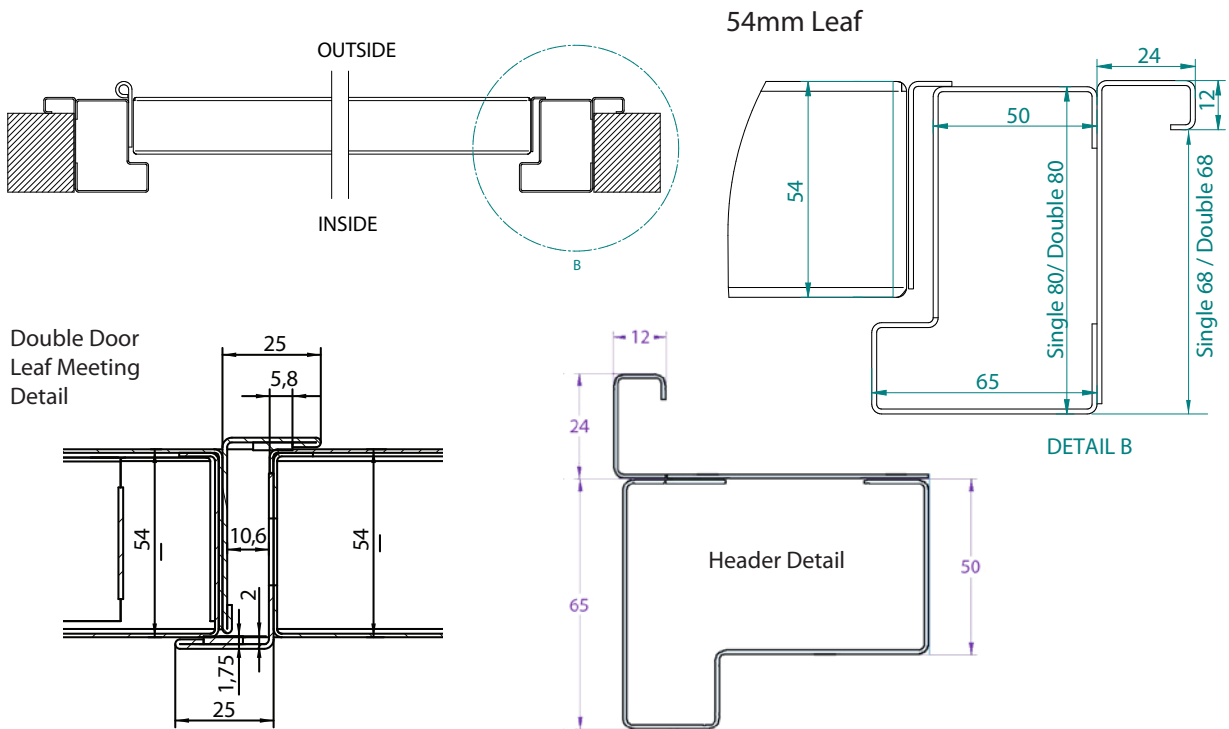

DuraPass Therma+ 54mm Leaf Odd Leg Frame – Open In

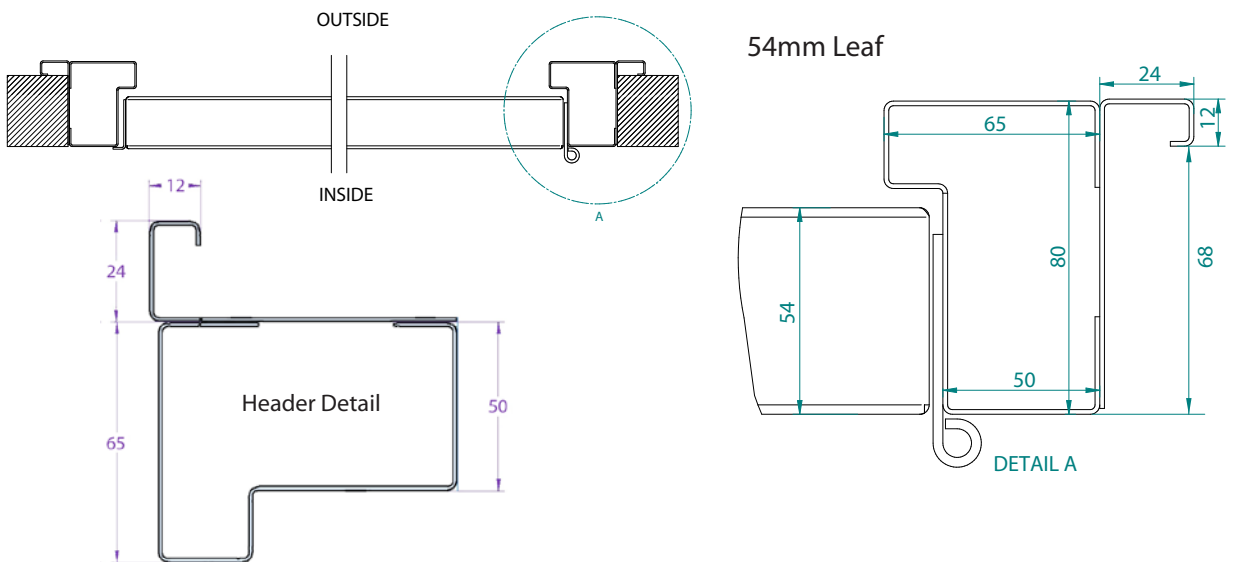

Threshold Options

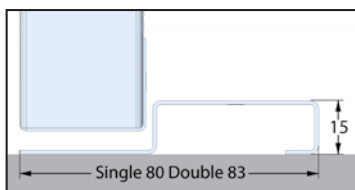

Standard open out
15mm low profile threshold

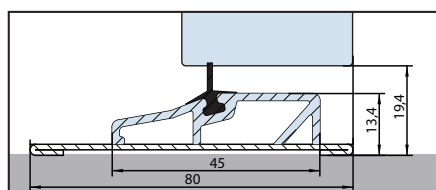

Standard inward opening
15mm low profile threshold

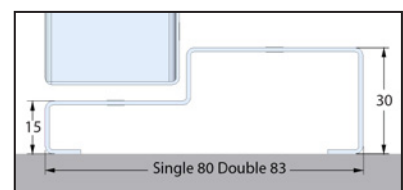

Optional 30mm open out threshold
(must be specified if required)

PDS strongly recommends a <5mm tolerance between finished opening size and over-frame (order) size to prevent frame distortion which will affect performance.

Size Specification - Popular industry standard sizes below or available made to measure!

Door Thickness (mm)	Frame Size (mm)	Internal Size (mm)	Clear Opening at 90° (mm)	Clear Opening at 180° (mm)
54	890 x 2095	760 x 2015	650	760
54	910 x 2065	780 x 1985	670	780
54	990 x 2095	860 x 2015	750	860
54	1130 x 2065	1000 x 1985	890	1000
54	1210 x 2065	1080 x 1985	970	1080

Double Leaf Doors

54	1894 x 2065 (equal)	1784 x 1995	755 (master)	865 (master)
54	1894 x 2065 (unequal)	1784 x 1995	890 (master)	1000 (master)

54mm Door Leaf Single Leaf Doors (open in or open out)

Max Overframe Width = 1210mm Min Overframe Width = 790mm
Max Overframe Height = 2300mm Min Overframe Height = 1785mm

54mm Door Leaf Double Leaf Doors (open out only)

Max Overframe Width = 2300mm Min Overframe Width = 1585mm
Max Overframe Height = 2300mm Min Overframe Height = 1785mm

Asymmetric doors' master leaf is always 1000mm clear opening at 180°

Specification Notes:

- Stainless steel handle with ERA multi-point locking
- Four security-pinned stainless steel hinges per leaf
- Double door inactive leaf edge surface mounted top shoot bolt
- Double door inactive leaf foot operated door stop
- Double door inactive leaf optional surface shoot bolts to top and bottom
- CE marked

NEW!
DuraPass Thermo+ Doors are compliant with Part L of the latest building regs for U-Values in both England (1.6) & *Scotland (1.4)
*Effective from Feb 2023
(see page 18 for details)

54mm Door Leaf U-Values:

Single Unglazed Open Out/In	1.4 U-Value
Single Double Glazed Open Out/In	1.6 U-Value
Double Unglazed Open Out/in	1.4 U-Value
Double Double Glazed Open Out/In	1.6 U-Value*

*Confirmation Pending

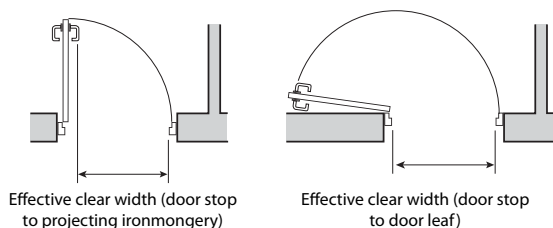

The rear face of the door panel on all standard colour doors is finished in a soft-white light reflecting finish. The frame will match the finish of the front face. The contrast between door leaf and frame assists with EA compliance for Visual Contrasts and Light Reflective Values (LRV). Shown right is a Goosewing Grey door from the inside - White inner face, Goosewing Grey Frame.





DuraPass Therma+ 74mm Leaf Odd Leg Frame – Open Out

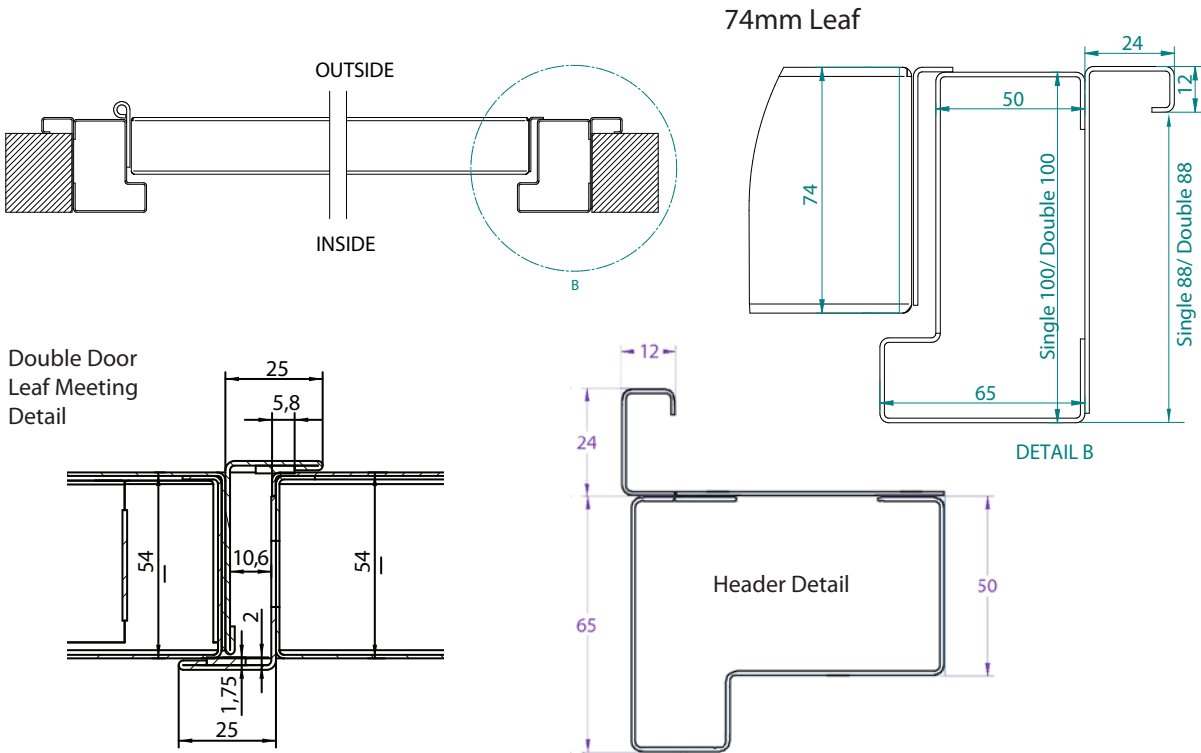

DuraPass Therma+ 74mm Leaf Odd Leg Frame – Open In

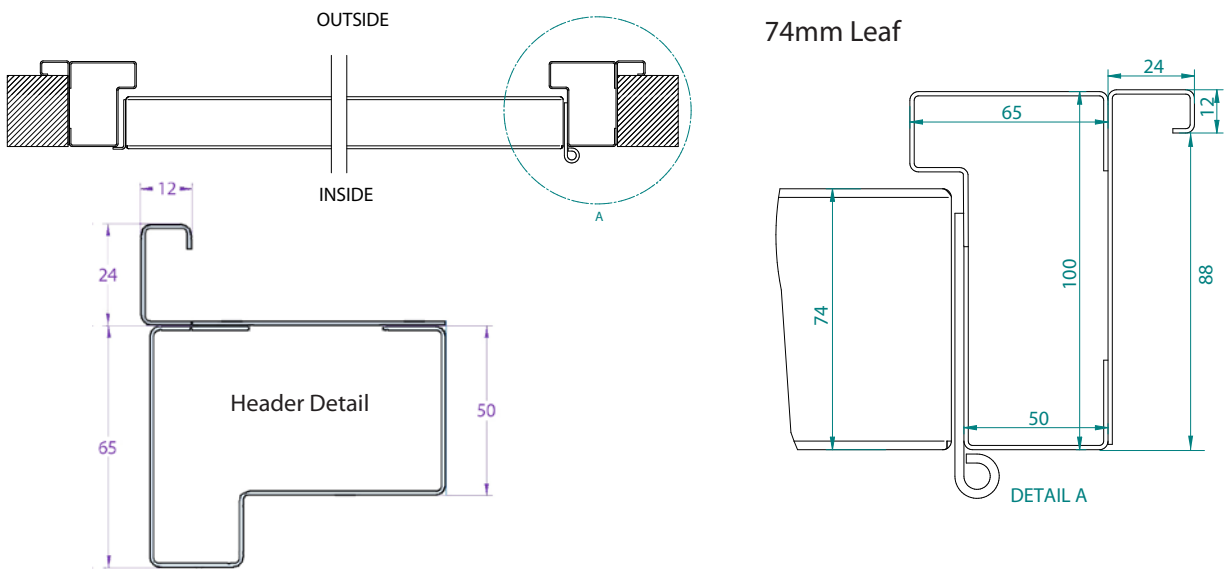

Threshold Options

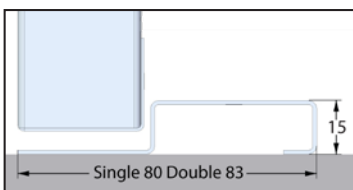

Standard open out
15mm low profile threshold

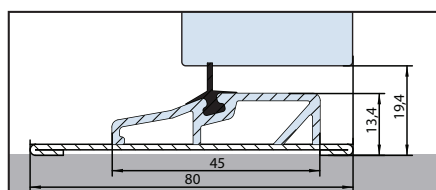

Standard inward opening
15mm low profile threshold

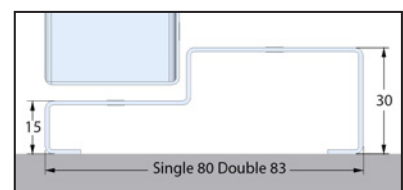

Optional 30mm open out threshold
(must be specified if required)

PDS strongly recommends a <5mm tolerance between finished opening size and over-frame (order) size to prevent frame distortion which will affect performance.

Size Specification - Popular industry standard sizes below or available made to measure!

Door Thickness (mm)	Frame Size (mm)	Internal Size (mm)	Clear Opening at 90° (mm)	Clear Opening at 180° (mm)
74	890 x 2095	760 x 2015	630	760
74	910 x 2065	780 x 1985	650	780
74	990 x 2095	860 x 2015	730	860
74	1130 x 2065	1000 x 1985	870	1000
Double Leaf Doors				
74	1894 x 2065 (equal)	1784 x 1995	735 (master)	865 (master)
74	1894 x 2065 (unequal)	1784 x 1995	870 (master)	1000 (master)

74mm Door Leaf Single Leaf Doors (open in or open out)

Max Overframe Width = 1170mm Min Overframe Width = 790mm
 Max Overframe Height = 2300mm Min Overframe Height = 1785mm

74mm Door Leaf Double Leaf Doors (open out only)

Max Overframe Width = 2250mm Min Overframe Width = 1585mm
 Max Overframe Height = 2300mm Min Overframe Height = 1785mm
 Asymmetric doors' master leaf is always 1000mm clear opening at 90°

Specification Notes:

- Stainless steel handle with ERA multi-point locking
- Four security-pinned stainless steel hinges per leaf
- Double door inactive leaf edge surface mounted top shoot bolt
- Double door inactive leaf foot operated door stop
- Double door inactive leaf optional surface shoot bolts to top and bottom
- Vision panel doors include 250mm x 1200mm triple glazed argon filled units with warm edge spacers and climaguard glass
- CE marked

NEW!
 DuraPass Thermo+ Doors are compliant with Part L of the latest building regs for U-Values in both England (1.6) & *Scotland (1.4)
 *Effective from Feb 2023
 (see page 18 for details)

74mm Door Leaf U-Values:

Single Triple Glazed Open Out	1.3 U-Value
Single Triple Glazed Open In	1.4 U-Value
Double Triple Glazed Open Out	1.4 U-Value
Double Triple Glazed Open In	1.6 U-Value*

*Confirmation Pending

NOTE: For unglazed doors 54mm leaves achieve 1.4 U-Value, please see page 3.

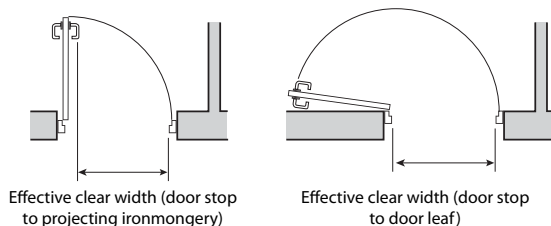

DuraPass Thermo+ 74mm leaf doorsets have 250mm x 1200mm triple glazed argon filled units with warm edge spacers and climaguard glass that have been tested to achieve Part L compliant U Value 1.3.

U Value 1.3

The rear face of the door panel on all standard colour doors is finished in a soft-white light reflecting finish. The frame will match the finish of the front face. The contrast between door leaf and frame assists with EA compliance for Visual Contrasts and Light Reflective Values (LRV). Shown right is a Goosewing Grey door from the inside - White inner face, Goosewing Grey Frame.



DuraPass Cabin Door 44mm Leaf Odd Leg Frame - Open Out

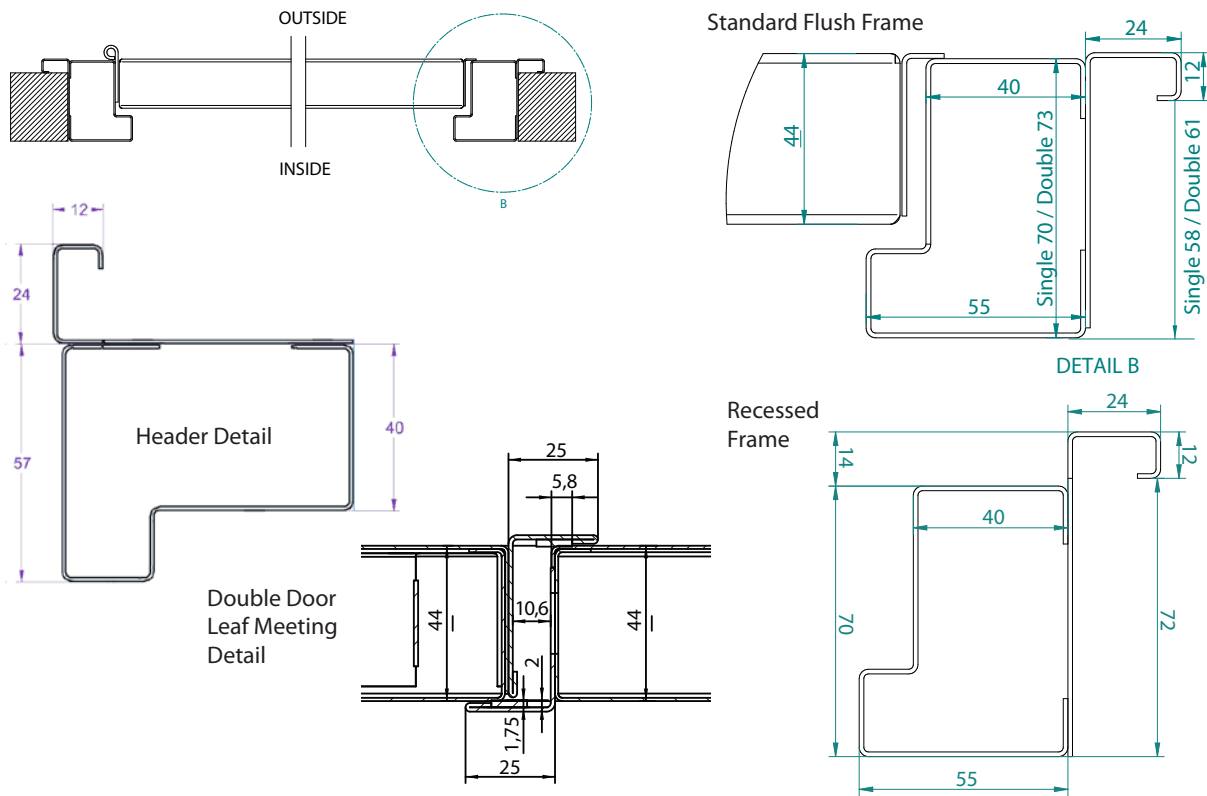

DuraPass Cabin Door 44mm Leaf Odd Leg Frame - Open In

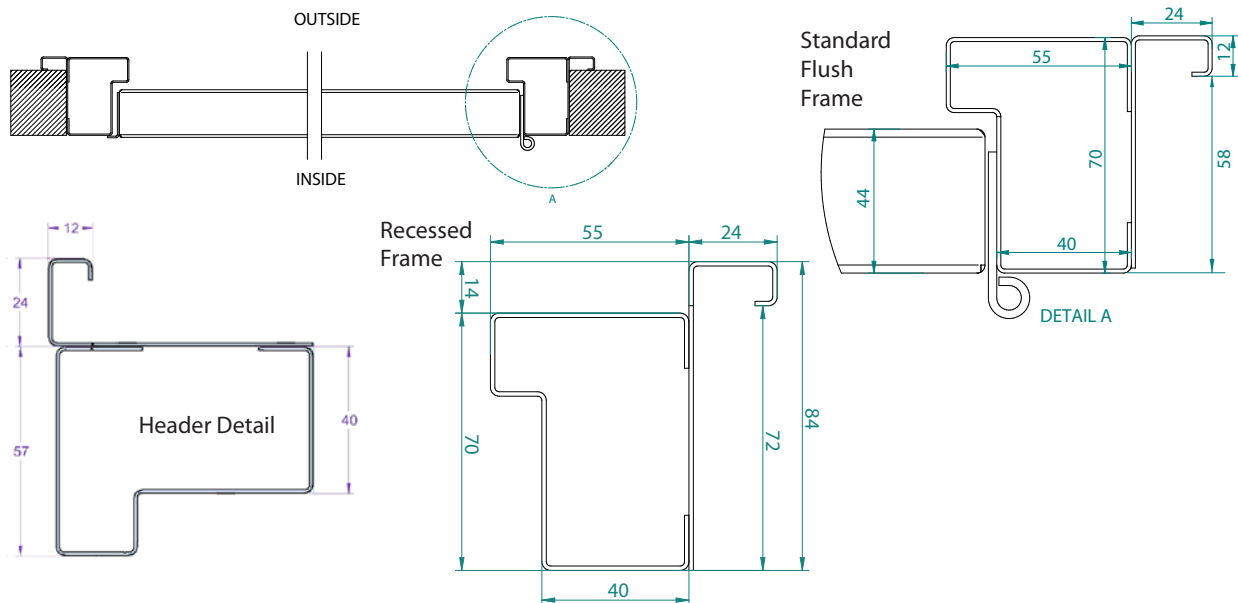

Threshold Options

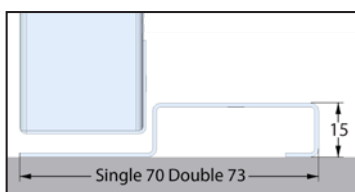

Standard open out
15mm low profile threshold

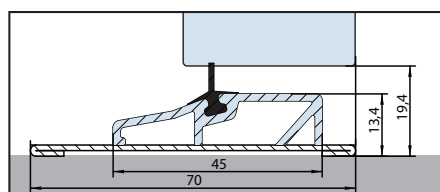

Standard inward opening
15mm low profile threshold

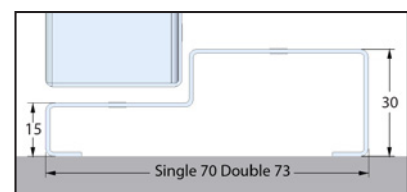

Optional 30mm open out threshold
(must be specified if required)

PDS strongly recommends a <5mm tolerance between finished opening size and over-frame (order) size to prevent frame distortion which will affect performance.

Size Specification - Popular industry standard sizes below or available made to measure!

Frame Size (mm)	Internal Size (mm)	Clear Opening at 90° (mm)	Clear Opening at 180° (mm)	Door Thickness (mm)
890 x 2095	780 x 2025	680	780	44
910 x 2065	800 x 1995	700	800	44
990 x 2095	880 x 2025	780	880	44
1110 x 2065	1000 x 1995	900	1000	44
1210 x 2065	1100 x 1995	1000	1100	44
Double Leaf Doors				
1894 x 2065 (equal)	1784 x 1995	792 (master)	892 (master)	44
1894 x 2065 (unequal)	1784 x 1995	1000 (master)	1100 (master)	44

Single Leaf Doors (open in or open out)

Max Overframe Width = 1210mm Min Overframe Width = 790mm
 Max Overframe Height = 2300mm Min Overframe Height = 1785mm

Double Leaf Doors (open out only)

Max Overframe Width = 2300mm Min Overframe Width = 1585mm
 Max Overframe Height = 2300mm Min Overframe Height = 1785mm

Asymmetric doors' master leaf is always 1000mm clear opening at 90°

Specification Notes:

- Stainless steel handle with ERA multi-point locking
- Four security-pinned stainless steel hinges per leaf
- Double door inactive leaf edge surface mounted top shoot bolt
- Double door inactive leaf foot operated door stop
- Double door inactive leaf optional surface shoot bolts to top and bottom
- CE marked

44mm Door Leaf U-Values:

Single Unglazed Open Out/In	1.9 U-Value
Single Single Glazed Open Out/In	2.8 U-Value
Double Unglazed Open Out/In	1.9 U-Value
Double Single Glazed Open Out/In	2.8 U-Value*

*Confirmation Pending

Louvre Options:

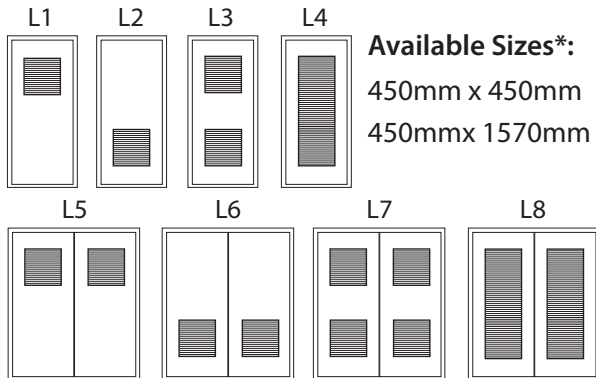

Louvre are centred in the upper half and/or bottom half of the door leaf.

Please note: Louvres will affect the U-Value.

*Minimum door leaf size to accommodate Louvres is 650mm.

The rear face of the door panel on all standard colour doors is finished in a soft-white light reflecting finish. The frame will match the finish of the front face. The contrast between door leaf and frame assists with EA compliance for Visual Contrasts and Light Reflective Values (LRV).

Shown right is a Goosewing Grey door from the inside - White inner face, Goosewing Grey Frame.

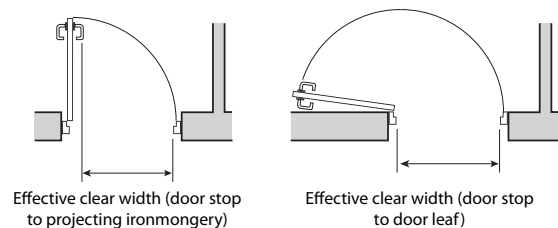

DuraPass Standard 44mm Leaf 70mm Frame – Open Out

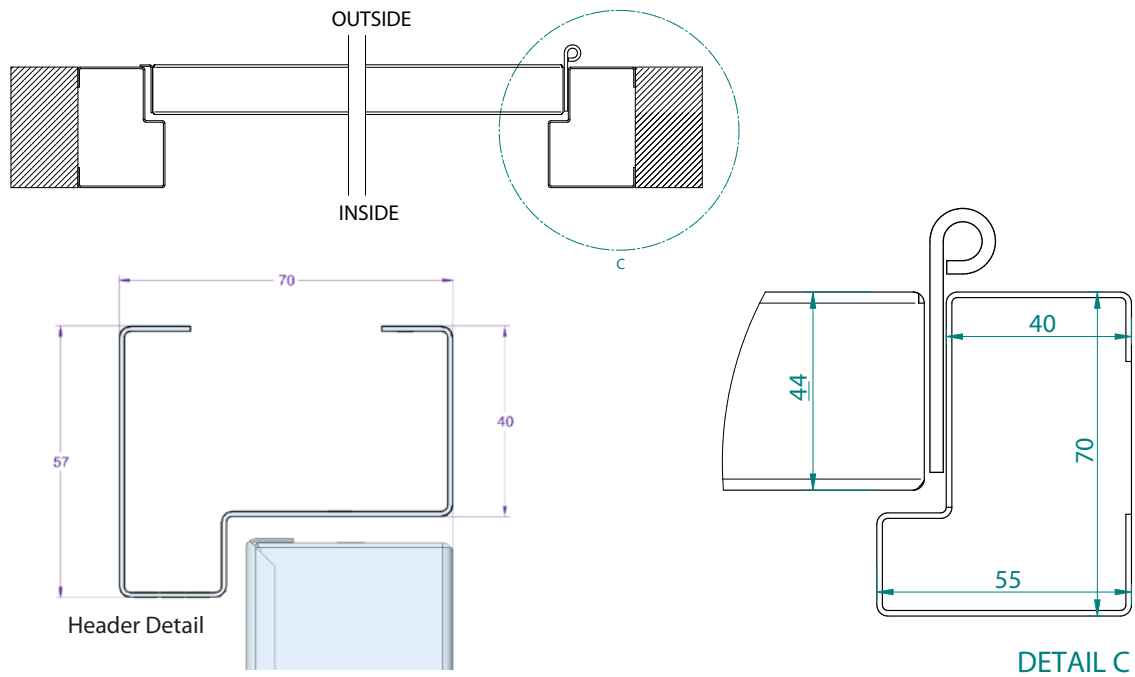

DuraPass Standard 44mm Leaf 70mm Frame – Open In

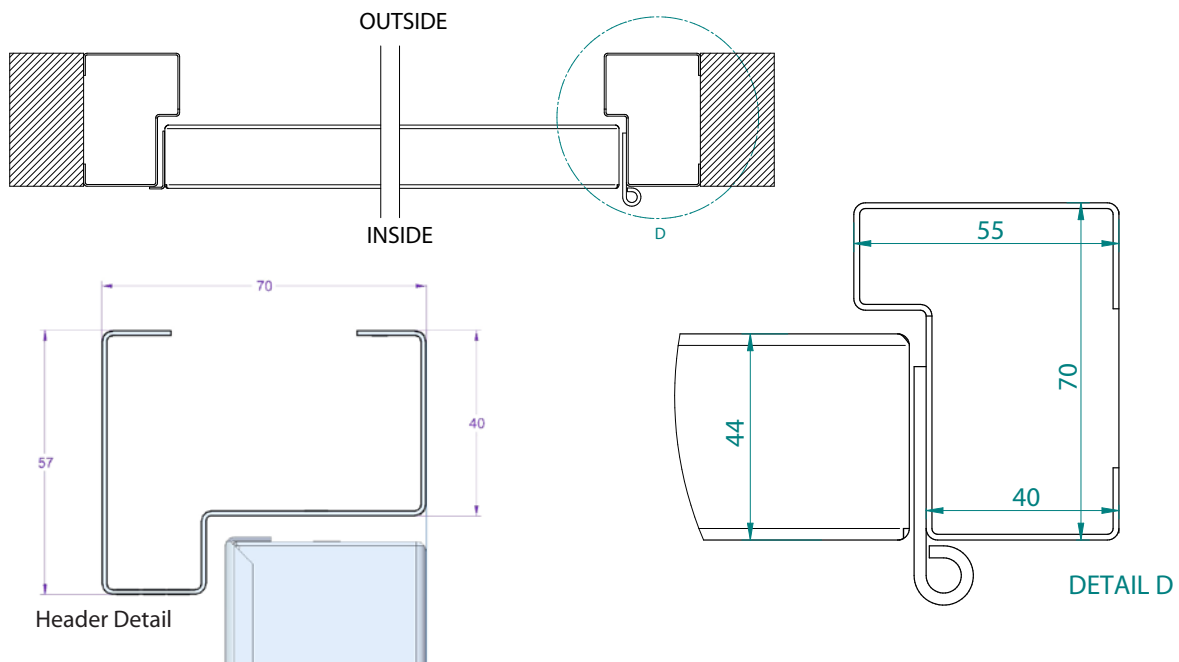

Threshold Options

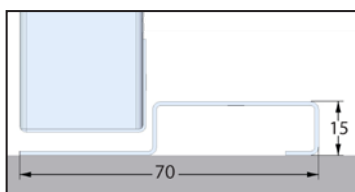

Standard open out
15mm low profile threshold

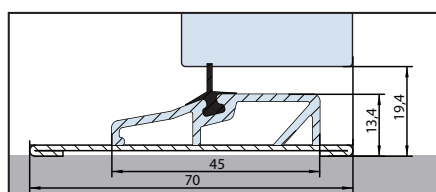

Standard inward opening
15mm low profile threshold

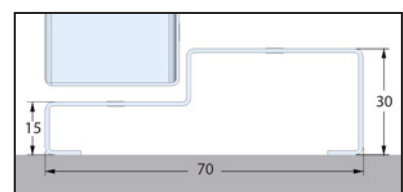

Optional 30mm open out threshold
(must be specified if required)

PDS strongly recommends a <5mm tolerance between finished opening size and over-frame (order) size to prevent frame distortion which will affect performance.

Size Specification - Popular industry standard sizes below or available made to measure!

Frame Size (mm)*	Internal Size (mm)	Clear Opening at 90° (mm)	Clear Opening at 180° (mm)	Door Thickness (mm)
890 x 1865	780 x 1795	680	780	44
890 x 2090	780 x 2020	680	780	44
890 x 2190	780 x 2120	680	780	44
890 x 2490	780 x 2420	680	780	44
960 x 2090	850 x 2020	750	850	44
990 x 1865	880 x 1795	780	880	44
990 x 2090	880 x 2020	780	880	44
990 x 2190	880 x 2120	780	880	44
990 x 2490	880 x 2420	780	880	44
990 x 2100	880 x 2030	780	880	44
1140 x 1865	1030 x 1795	930	1030	44
1140 x 2090	1030 x 2020	930	1030	44
1140 x 2190	1030 x 2120	930	1030	44
1140 x 2490	1030 x 2420	930	1030	44

Single Leaf Doors (open in or open out)

Max Overframe Width = 1210mm Min Overframe Width = 790mm
 Max Overframe Height = 2300mm Min Overframe Height = 1785mm

Double Leaf Doors (open out only)

Max Overframe Width = 2300mm Min Overframe Width = 1585mm
 Max Overframe Height = 2300mm Min Overframe Height = 1785mm

Asymmetric doors' master leaf is always 1000mm clear opening at 90°

Specification Notes:

Stainless steel handle with ERA multi-point locking

Four security-pinned stainless steel hinges per leaf

Double door inactive leaf edge surface mounted top shoot bolt

Double door inactive leaf foot operated door stop

Double door inactive leaf optional surface shoot bolts to top and bottom

CE marked

44mm Door Leaf U-Values:

Single Unglazed Open Out/In 1.9 U-Value

Single Single Glazed Open Out/In 2.8 U-Value

Double Unglazed Open Out/In 1.9 U-Value

Double Single Glazed Open Out/In 2.8 U-Value*

*Confirmation Pending

Louvre Options:

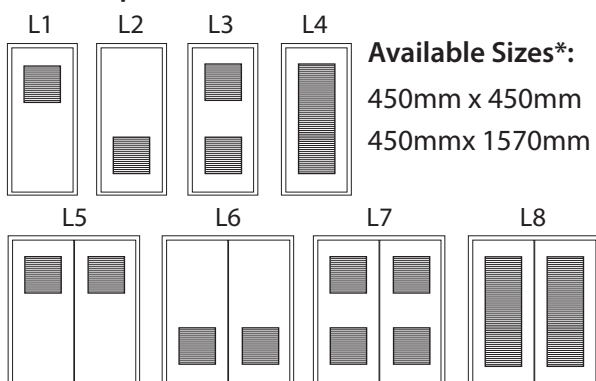

Louvre are centred in the upper half and/or bottom half of the door leaf.

Please note: Louvres will affect the U-Value.

*Minimum door leaf size to accommodate Louvres is 650mm.

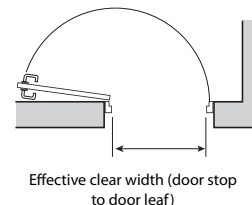
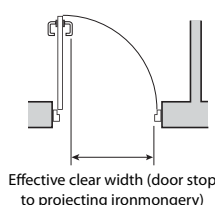

DuraPass Steel Buildings 44mm Leaf 40-65mm Flanged Frame – Open Out

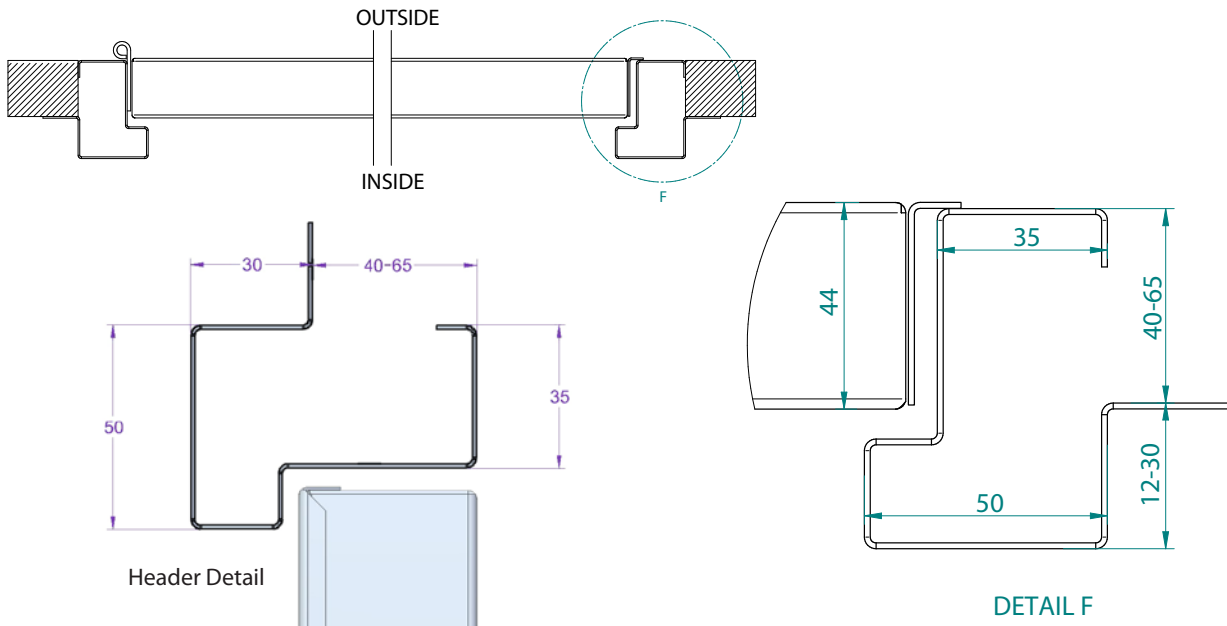

DuraPass Steel Buildings 44mm Leaf 40-65mm Flanged Frame – Open In

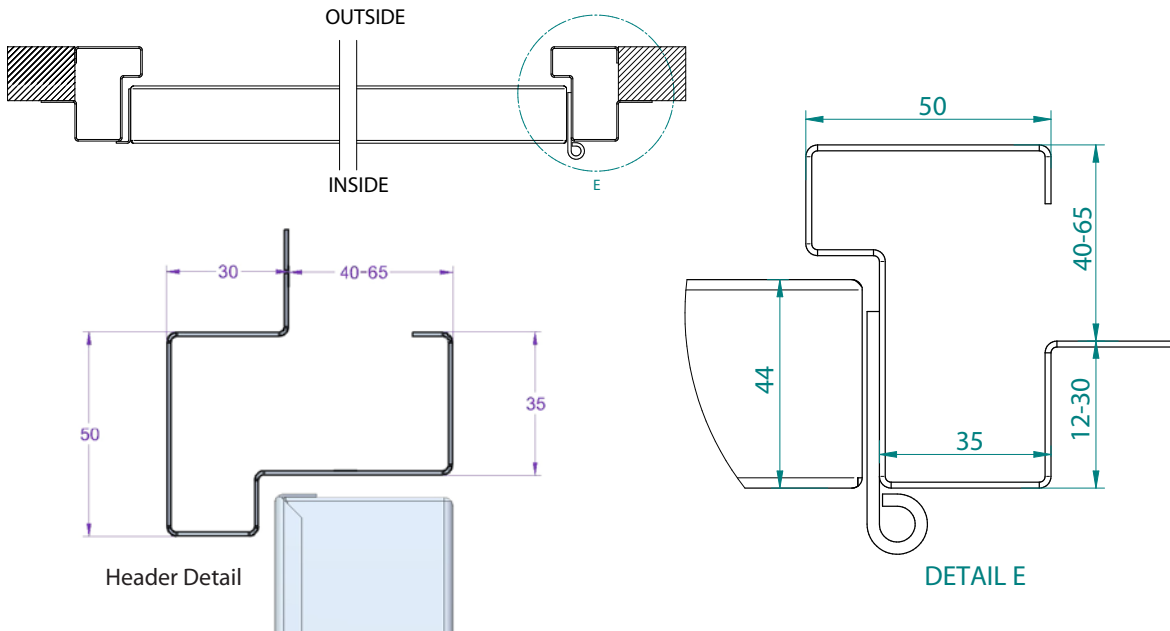

Threshold Options

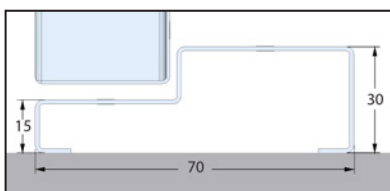

Standard 30mm open out threshold

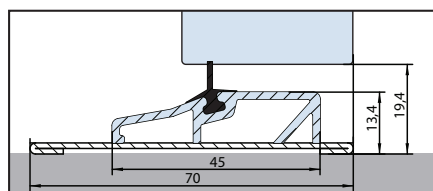

Standard inward opening 15mm low profile threshold

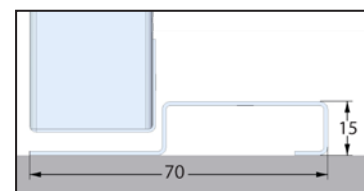

Optional open out 15mm low profile threshold (must be specified if required)

PDS strongly recommends a <5mm tolerance between finished opening size and over-frame (order) size to prevent frame distortion which will affect performance.

Size Specification - Popular industry standard sizes below or available made to measure!

Frame Size (mm)*	Internal Size (mm)	Clear Opening at 90° (mm)	Clear Opening at 180° (mm)	Door Thickness (mm)
890 x 2090	790 x 2025	690	790	44
900 x 1900	800 x 1835	700	800	44
915 x 2030	815 x 1965	715	815	44
942 x 1785	842 x 1720	742	842	44
990 x 2030	890 x 1965	790	890	44
990 x 2090	890 x 2025	790	890	44
990 x 2100	890 x 2035	790	890	44
1080 x 1785	980 x 1720	880	980	44
1080 x 2000	980 x 1935	880	980	44
1090 x 2090	990 x 2025	890	990	44

* 40mm - 65mm mm Frame Depth

Single Leaf Doors (open in or open out)

Max Overframe Width = 1210mm Min Overframe Width = 790mm
 Max Overframe Height = 2300mm Min Overframe Height = 1785mm

Double Leaf Doors (open out only)

Max Overframe Width = 2300mm Min Overframe Width = 1585mm
 Max Overframe Height = 2300mm Min Overframe Height = 1785mm

Asymmetric doors' master leaf is always 1000mm clear opening at 90°

Specification Notes:

- Stainless steel handle with ERA multi-point locking
- Four security-pinned stainless steel hinges per leaf
- Double door inactive leaf edge surface mounted top shoot bolt
- Double door inactive leaf foot operated door stop
- Double door inactive leaf optional surface shoot bolts to top and bottom
- CE marked

44mm Door Leaf U-Values:

Single Unglazed Open Out/In	1.9 U-Value
Single Single Glazed Open Out/In	2.8 U-Value
Double Unglazed Open Out/In	1.9 U-Value
Double Single Glazed Open Out/In	2.8 U-Value*

*Confirmation Pending

Louvre Options:

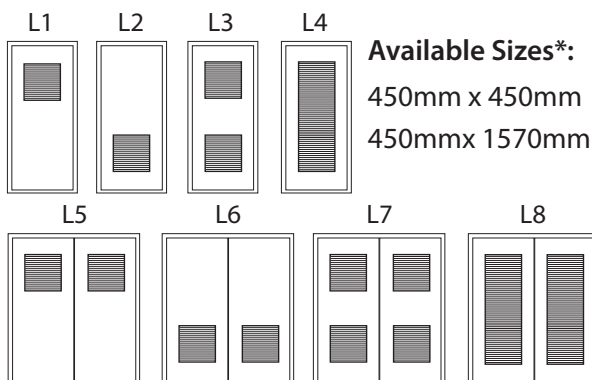

Louvre are centred in the upper half and/or bottom half of the door leaf.

Please note: Louvres will affect the U-Value.

*Minimum door leaf size to accommodate Louvres is 650mm.

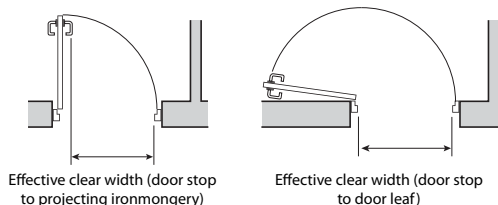

Pass Door Vision Panels

Vision Panel Options

Clear Windows Specification:

- EN - 12150 Compliant: Thermally toughened safety glass to British Standard EN -12150.
- BS - EN 1279 Compliant: British Standard for insulating glass units.

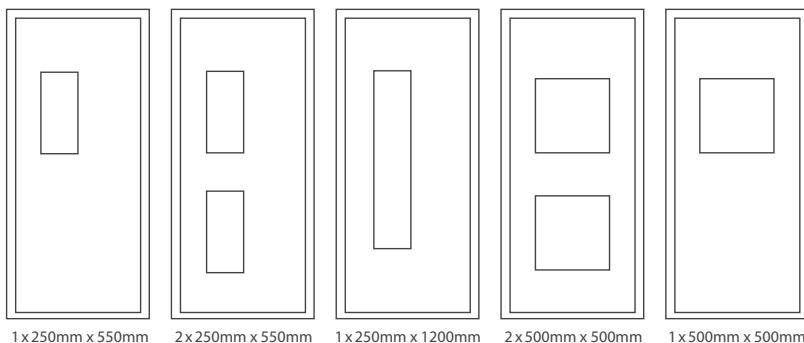

1 x 250mm x 550mm 2 x 250mm x 550mm 1 x 250mm x 1200mm 2 x 500mm x 500mm 1 x 500mm x 500mm

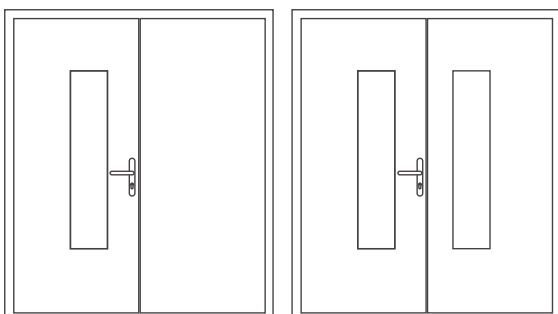

1 x 250mm x 1200mm 2 x 250mm x 1200mm



DuraPass Therma+ 74mm leaf doorsets have 250mm x 1200mm triple glazed argon filled units with warm edge spacers and climaguard glass that have been tested to achieve Part L compliant U Value 1.3.

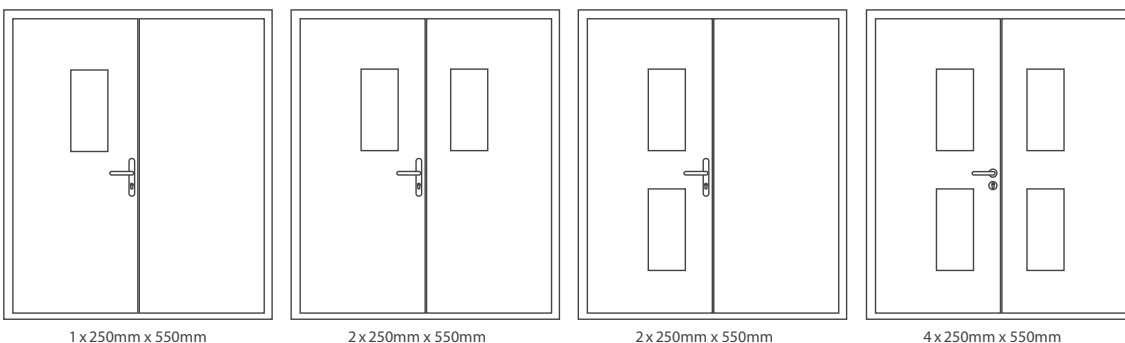

1 x 250mm x 550mm 2 x 250mm x 550mm 2 x 250mm x 550mm 4 x 250mm x 550mm

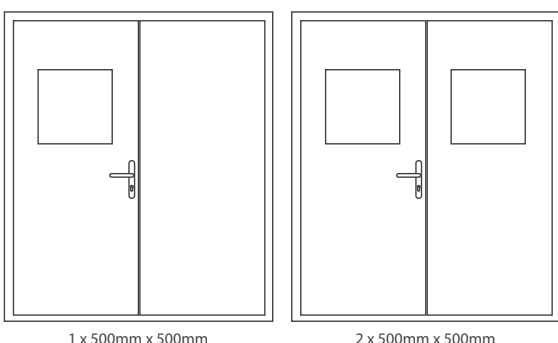

1 x 500mm x 500mm 2 x 500mm x 500mm

DuraPass Therma+ Doors are compliant with Part L of the latest building regs for U-Values in both England (1.6) & *Scotland (1.4) See pages 2-5! *Effective from Feb 2023

NEW! U Value 1.4

Pass Door Closers

Closer Specification

Arrone AR5200 Heavy Duty Closer

Spring Power Adjustable Overhead Closer

- Adjustable power size 2 - 5
- Backcheck facility
- Slide Cover
- CE Marked to EN 1154

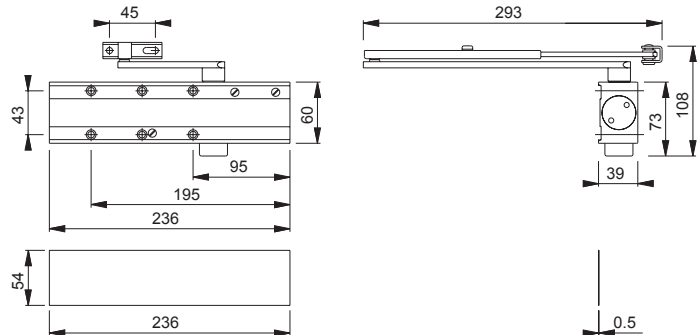

Carlisle Brass CDG003 Medium Duty Closer

Fixed Power Compact Overhead Closer

- CE Marked to EN 1154
- EN Power 3
- Adjustable closing speed and latch action

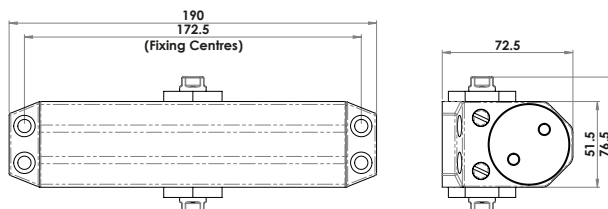

EN Closer power settings

Within EN 1154 seven closer power ratings are identified according to the maximum door leaf weight and width.

These are theoretical figures and the final closing power of any door closing device will be subject to any number of variables such as:

- Accuracy of closer installation
- Accuracy of door installation
- Friction in hinges
- Negative or positive air pressure

Because of such variables, the specification of an adjustable door closer is recommended to allow for site variables.

EN Size	Max. door weight (kg)	Max. door width (mm)
1	20	750
2	40	850
3	60	950
4	80	1100
5	100	1250
6	120	1400
7	160	1600

Size range covered by Pass Door closer options.



Within the detail of BS 8300 and Approved Document M of Building Regulations, there is a requirement to achieve low opening forces to satisfy the need for easy and universal accessibility. See Page 15 for more information.

Pass Door Panic Functions

Panic Function

EN 1125 - panic applications 296 Single Panic Push Bar Single Latch

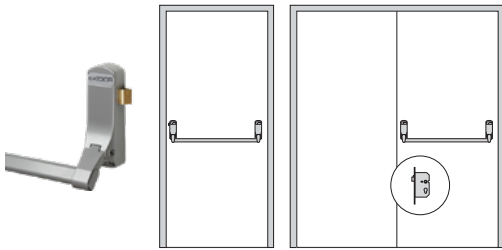

EXIDOR 

The Exidor 296 is designed for single and double door applications. The unit is operated by a downward thrust of the cross bar to give a speedy exit in panic situations.

EN 1125 - panic applications 285 Double Panic Push Bar with Single Latch & 2 Point Bolt

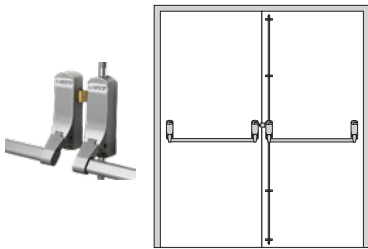

EXIDOR 

The Exidor 285 for rebated double doors is a complete package consisting of panic latch, a panic bolt and a box keep.

EN 179 - panic applications 297 Push Pad Single Latch

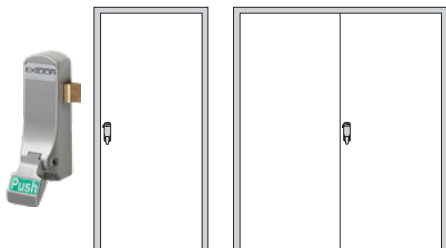

EXIDOR 

The Exidor 297 is a surface mounted rim latch for single and double door applications. Simply depressing the pad provides safe and speedy exit in the event of an emergency, whilst maintaining security against intrusion.

322EC Lever Operated Outside Access Device

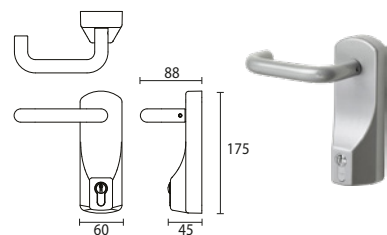

EXIDOR 

The Exidor 322 offers a lever operated outside access device that meets the dimensional requirements of BS8300 and approved Document "M" (EA).

The 322 is supplied with 3 keys and has the advantage that a master keyed 45mm Euro profile cylinder can be used. The 322 offers access from the outside of the door.

The 322EC works with the 296, 285 and 297 push bars/pad (above).

CL500 Code Lock

Works with

EXIDOR

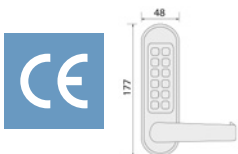

Option 1 - CL500 Code Lock with Exidor Push Pad

The CL500 Code Lock works in conjunction with the Exidor 297 Push Pad as shown.

Option 2 -CL500 Code Lock with CL525 Mortice Lock

CL500 that incorporates an internal handle and can be used for open-in scenarios.

Please specify which option is required at point of order.

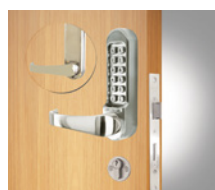

Options

National Key Scheme

Door are available with a National Key Scheme lock set that can only be operated by using special NKS or RADAR keys.

Access is by key and 'D' handle pull bar, internally, locking is with an accessibility lever handle. A stainless steel grab rail is included to be fitted internally.

Standard Lock, Lever Set, Stainless Steel Exterior 'D' Handle and Stainless Steel Internal Grab Rail

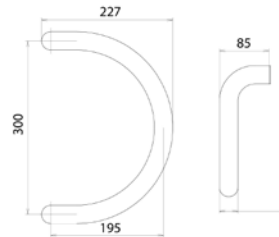

Child Finger Protection Guards

Finger protection strips are anti-trapping devices that protect children's fingers at the most dangerous side of the door: the hanging side.

FP90 for the Push Side

FP50 for the Pull Side

Finger protection strips are tested to the new British Standard: BS 8613:2017 Finger protection devices for pedestrian doors.

Tested to Class 2 Device classification of this standard: products which prevent access to the gap when force is used, or eliminate the gap.

Tested to Grade 4 (240 hours neutral salt spray exposure) in accordance with BS EN 1690:007 Building Hardware – Corrosion Resistance.



1800mm length – Colour Black

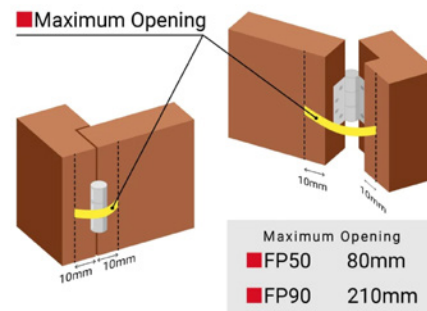
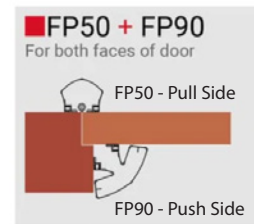

Rain Deflectors & Rain Guards

Rain deflectors are available as an option fitted to the bottom of the door deflecting water from the threshold seal, reducing the risk of water ingress.

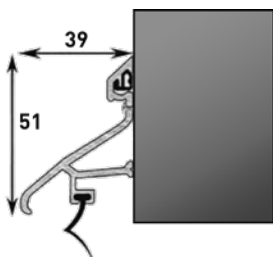

Rain guards are available as an option fitting to the top of the door to help repel moisture and wind-driven rain infiltration.

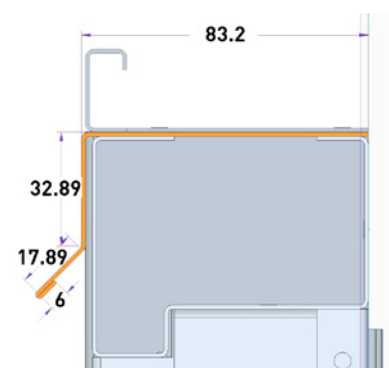



Regulations and Standards - The Equality Act (EA) 2010

The Equality Act (EA) 2010 incorporated (and repealed) the DDA, rendering the term 'DDA compliant' obsolete.

The EA incorporates protection provided for disabled people by the DDA, but is broader in its application. It covers services in the commercial, retail, financial, residential, education, healthcare and transport sectors.

As the EA relates to **access to services** rather than to premises, consequently buildings and products cannot be 'EA compliant'.

Instead, they must comply with either Part M of the Building Regulations or the recognised technical standard BS 8300.

Despite this, DDA compliance is still the way many people refer to accessibility regarding doors.

Put simply, doors and the related access considerations around them need to be specified to meet the requirements of Approved Document M of the Building Regulations, using products that need to meet the codes of practice set out in BS 8300.

Regulations and Standards - Building regulations Part M

Approved Document M of the Building Regulations (access to and use of buildings) is often referred to as Part M or ADM, and provides guidance on the design and construction of buildings to ensure access and inclusion for all.

- Significant amendments to Part M came into effect in 2010 and 2013. These changes included updated guidance on door opening forces and changing places/toilets.
- Updated guidance on guardrails and handrails and manifestation for glass doors and glazed screens moved to Approved Document K (ADK): Protection from falling, collision and impact.

Regulations and Standards - BS 8300

BS 8300 is the code of practice that helps disabled people make the most of their surroundings through architectural design in the built environment. It looks at the provision of aids and the use of features such as ramps, guardrails and signs. The code is officially known as BS 8300: 2009+A1: 2010 (Design of buildings and their approaches to meet the needs of disabled people - Code of practice).

However, it is incorrect to assume compliance with Part M alone will meet the requirements of the EA. Also, it should be noted that the requirements of Part M and BS 8300 are 'minimum standards'.

To clarify how Part M impacts door specification we need to consider the following:

- **Space** – this is the space around a door, which, if in a wheelchair, will also determine how you approach the door, either head on or at an angle. This will impact the clear opening width required. The direction and width of approach determines the width of the door specification, due to the angle of the door. This normally isn't an issue with an external door. External doors should not open out if they present a hazard to pedestrians (i.e. you open the door and hit someone). This can be dealt with either by recessing the door within a reveal so that it opens out but within the building line, installing clearly visible handrails or, if all else fails, open the door in.
- **Visibility** – this impacts the specification of the vision panels and also the ironmongery, as explained in section 6 of this document. Contrast is required between the ironmongery and the colour of the door. The contrasting finishes of the ironmongery (handle) and the face of the door must give the minimum light reflective value (LRV) of 30 points. There is also a requirement for architraves and/or frames to contrast with the wall. This contrast also applies to the edge of a door if the door is open at 90 degrees - such as doors on hold open devices in hospitals. In this event the edge of the door should contrast with either the face of the door if open at an angle; or if at 90 degrees then contrast with the frame/architrave as well (further information on this can be found in BS 8300 7.2.5).

Regulations and Standards - BS 8300

- **Door approach** – this is determined as covered above by the available space to approach the door. For example, if you're coming down the corridor in a wheelchair and the door is in the corner, there may be insufficient width in the corridor for you to get through.
- **Access (ramps)** – If you have a ramp rising from one side of a door to another, you need to consider which way the door opens. Invariably you get a ramp leading up to a door with a flat walkway on the other side. However there are instances in which you could have an ascending ramp interrupted with a fire door; in this instance the door must open away from the ascent.
- **Closing force** – this is principally a function of ironmongery; the heavier or wider the door the more powerful the closer required. Conflicting requirements can arise between the force needed to close a door and the maximum strength required to satisfy Part M. The power of the closer may have to be reduced to meet Part M requirements.
The closing force can be impacted by the flow of air (differential air pressure) through the building's space making the door difficult to close. This is

common around fire doors in multi occupancy buildings. It is possible to specify fire resisting vents/grills in the door which will allow air to pass through the door to reduce pressure. In some buildings, air pressure can create closing issues for external doors as the force required for closing is too high to comply with Part M. This problem is common in care homes with large heavy external doors. The less able may not be able to open the door if the closer is too strong; the remedy for this is to install powered closers.

- **Door thresholds** – to meet the requirements of Part M, door thresholds should be a maximum of 15mm; the threshold should be chamfered or rounded for ease of wheelchair access.

These door specification considerations relate directly to four main areas of Part M:

- Clear opening widths
- Threshold heights
- Visibility requirements
- Self-closing devices

Minimum Effective Clear Opening Widths (ECW)

Direction and width of approach	New Buildings (mm)	Existing Buildings (mm)
Straight-on (without a turn or oblique approach)	800	750
At right angles to an access route at least 1500mm wide	800	750
At right angles to an access route at least 1200mm wide	825	775
External doors to buildings used by the general public	1000	775

Note:

The effective clear width is the width of the opening measured at right angles to the wall in which the door is situated from the outside of the door stop on the door closing side to any obstruction on the hinge side, whether this be projecting door opening furniture, a weather board, the door or the door stop (See diagram 9).

Diagram 9 Effective clear width of doors

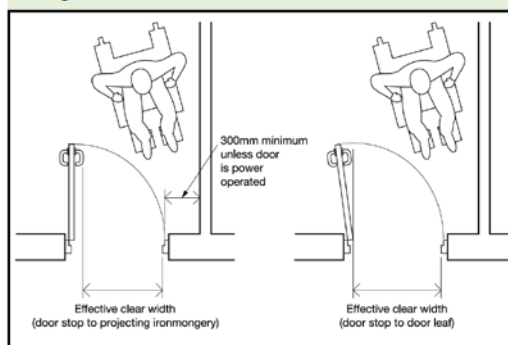



Threshold Heights

Any change in surface or level, such as gradients and upstands found at door thresholds, can be problematic for wheelchairs, the visually impaired and less able.

To meet the requirements set out in BS8300, thresholds should preferably be level.

There are cases where a raised threshold is unavoidable, usually to prevent water ingress. In these cases the threshold should have a maximum height of 15mm.

Any upstand more than 5mm high should have exposed edges chamfered or round to minimise problems with access.

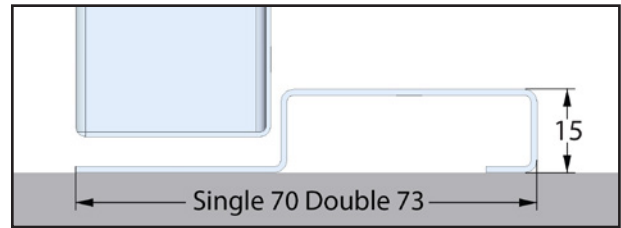
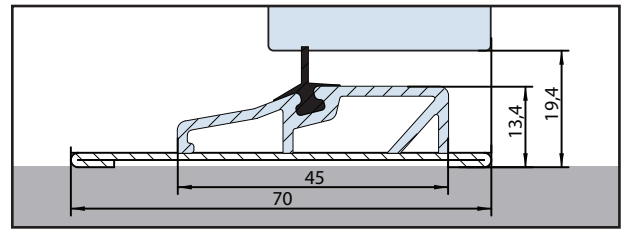

Visibility Requirements

People should be able to view others approaching or standing either side of a door to avoid the risk of collision. (There may be circumstances where for reasons of privacy or security this may not be appropriate or possible).

The diagram below shows the minimum requirements to satisfy Part M.

(Please note that this diagram is now shown in Part K of the Building Regulations, not Part M. It is referenced in Part M).

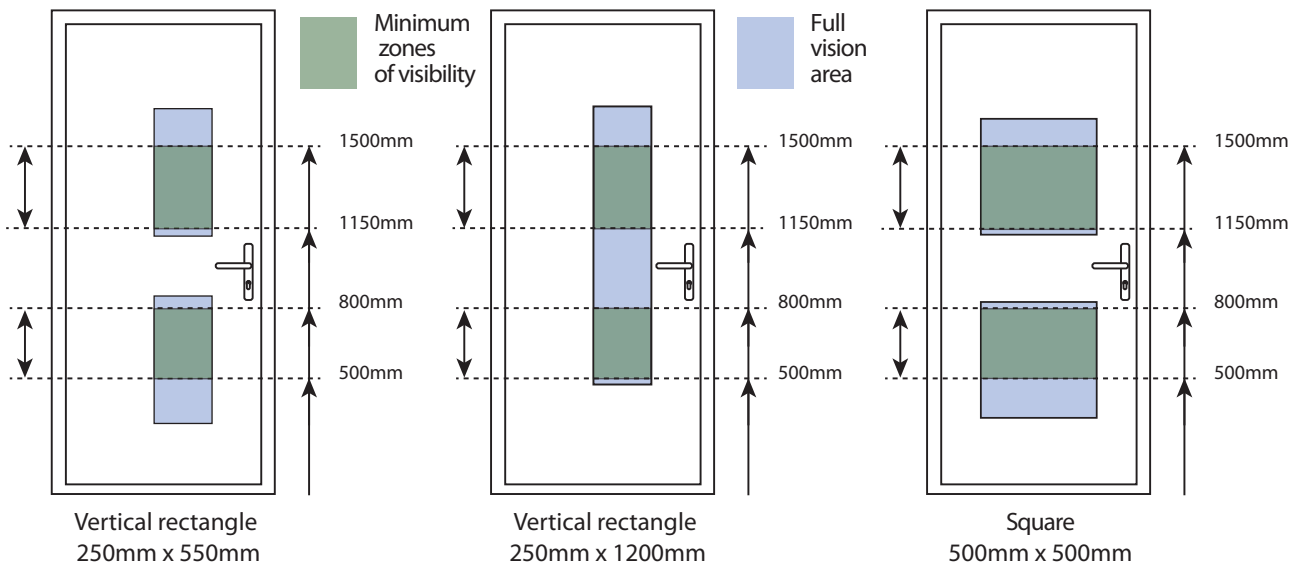

Visual Contrasts – Light Reflective Values (LRV)

Visual contrasts are required between ironmongery and door surfaces. Also, for doors likely to be kept open (particularly at 90 degrees), a contrasting leading edge should be provided. Door frames and architraves should contrast with the adjacent wall colour.

Contrasts are measured by comparing the light reflective values (LRVs) of different materials and colours. Generally a LRV of a minimum of 30 points must apply to adjacent surfaces. (LRV is measured on a scale of 0 to 100 with 0 representing perfect absorbing black and 100 perfect reflecting white. In reality these perfect colours are not found – a bright white would typically have LRV of 85). Colour charts showing LRVs against each colour are available from leading paint manufacturers.



Self-closing Devices

Many doors are fitted with non-powered closers. This is particularly the case with fire doors, but often occurs on external doors as well. Part M (and BS 8300) requires that the opening force at the leading edge of the door is no greater than 30N from 0 degrees, that is the door closed to 30 degrees open, and not more than 22.5N from 30 to 60 degrees of the opening cycle.

This can sometimes create a conflict between satisfying ADM and closing the door: a conflict that can only be resolved by installing a powered closing device.



Part L Building regulations Conservation of fuel and power

The changes to building regulations introduced in 2022 define the minimum standards required for energy performance. The extracts below are from the regulations in England and Scotland.

ENGLAND Part L Section 10: New elements in existing buildings, including extensions states:

New and replacement windows, roof windows, rooflights and doors (controlled fittings)

10.3 If the entire unit of windows, roof windows, rooflights or doors is replaced, all the following apply.

- a. Units should be draught-proofed.
- b. Units should meet the minimum standards in Table 4.1. Limiting U-values for new or replacement elements in new and existing buildings: **Pedestrian doors (including glazed doors) 1.6**
- c. Insulated cavity closers should be installed where appropriate.

SCOTLAND Building (Scotland) Regulations 2004 and updated Technical Handbooks – Non-domestic - Energy, effective from February 1st 2023 state:

6.2.1 Maximum U-values for elements of the building envelope. Pedestrian doors 1.4.



Pass Door Systems is a specialist external doors manufacturer for Modular / Steel Sheds and external building companies throughout the UK & Ireland.



Steel Buildings



Modular Buildings

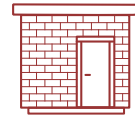

External Garages

- Industry popular sizes and made to measure options
- Excellent lead times from our highly automated facilities
- Full UK and Ireland service
- Proudly made in Ballymena (UK)



Proud to be a member of...



modular & portable building association



Raising Standards Safety Assured

NEW!



DuraPass
THERMA+ Personnel Doors

U Value 1.4

U-value 1.4 W/m²K

See pages 2-5!



Pass Door Systems Wakehurst Ind. Est.,
Ballymena, BT42 3AZ

T: +44 (0) 28 25 44 69 30

E: info@passdoorsystems.com

Web: www.passdoorsystems.com

Pass Door Systems reserves the right to alter specifications to design and manufacture without notification. All specifications are correct at time of publication, errors and omissions excepted. September 2023 Issue 1. Colours shown are for guide purposes only and are limited by the printing process.



PassDoorTech 09/23

NET ZERO

Helping you meet the new Part L regulations & support the drive for Net-Zero.

